

NVV113JT2 Installation drawing

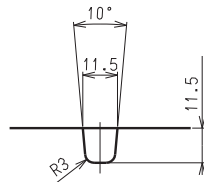

During low speed or high speed no
pressurize mode, input air here.
(Air for valve)

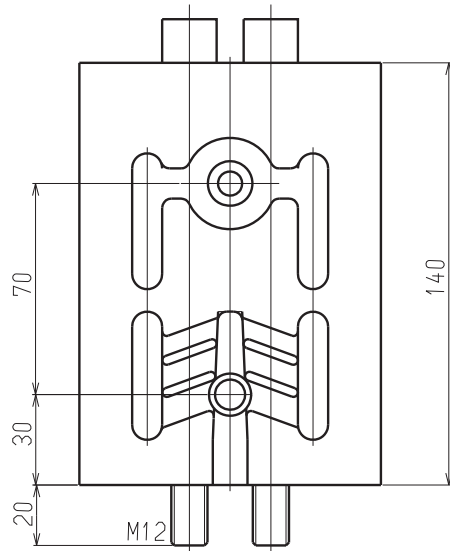
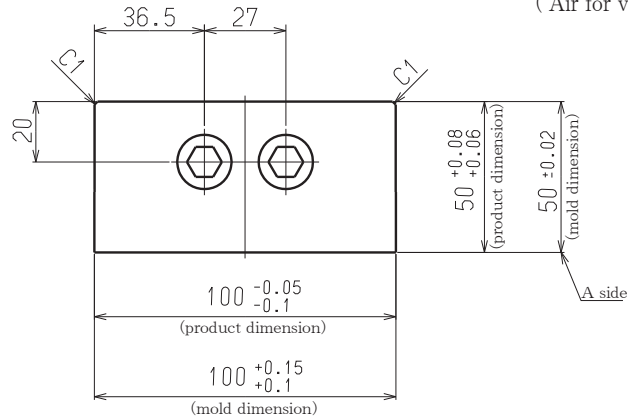
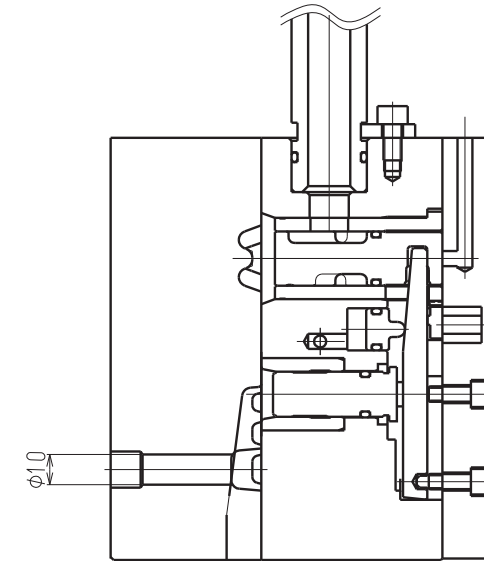
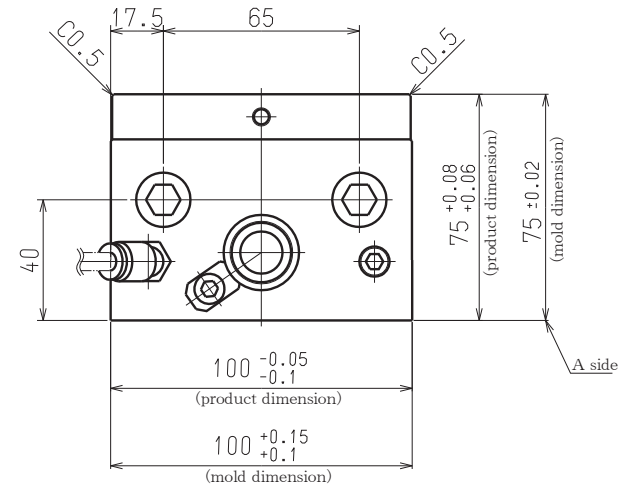
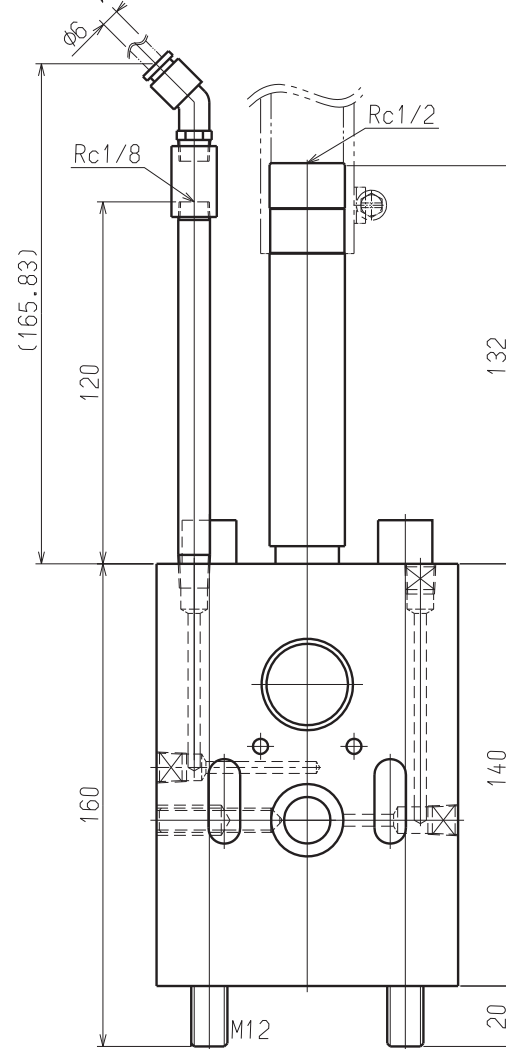

NOTE

- 1) A side is higher than PL side about 0.04 ~ 0.06.
- 2) If A side of fixed body and movable body are not closely may cause low effect of vacuum suction.