

NVV201NS2 取付関係図

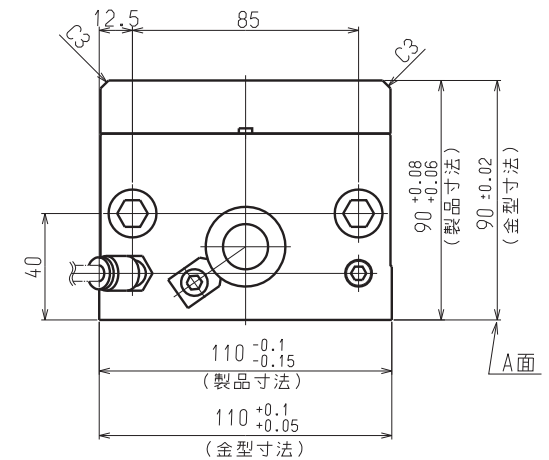
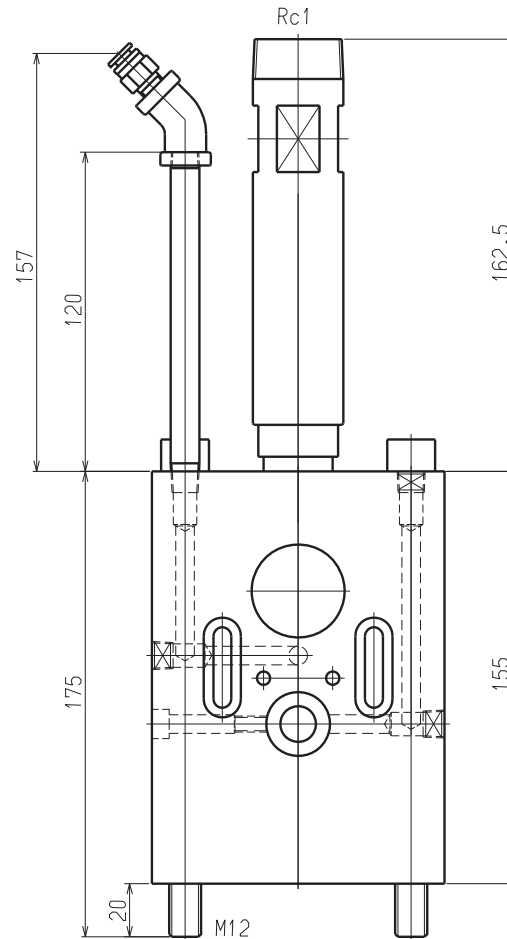
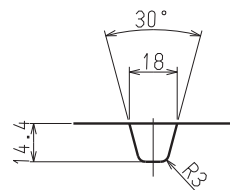
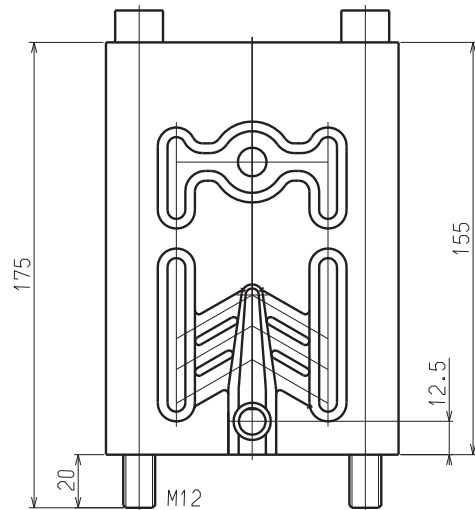
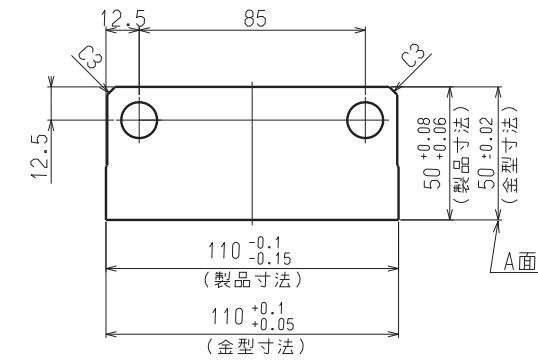
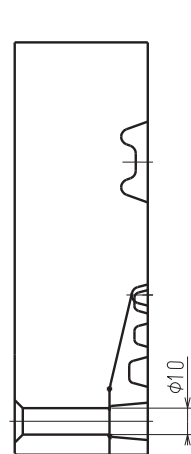

NOTE

- 1) A面はキャビティ PL面に対して凸 0.04~0.06 のこと。
- 2) 固定側 A面と可動側 A面が密着しないと真空効果が低下します。