

# ZM038 Installation drawing

During low speed or high speed no  
pressurize mode, input air here.  
( Air for valve )

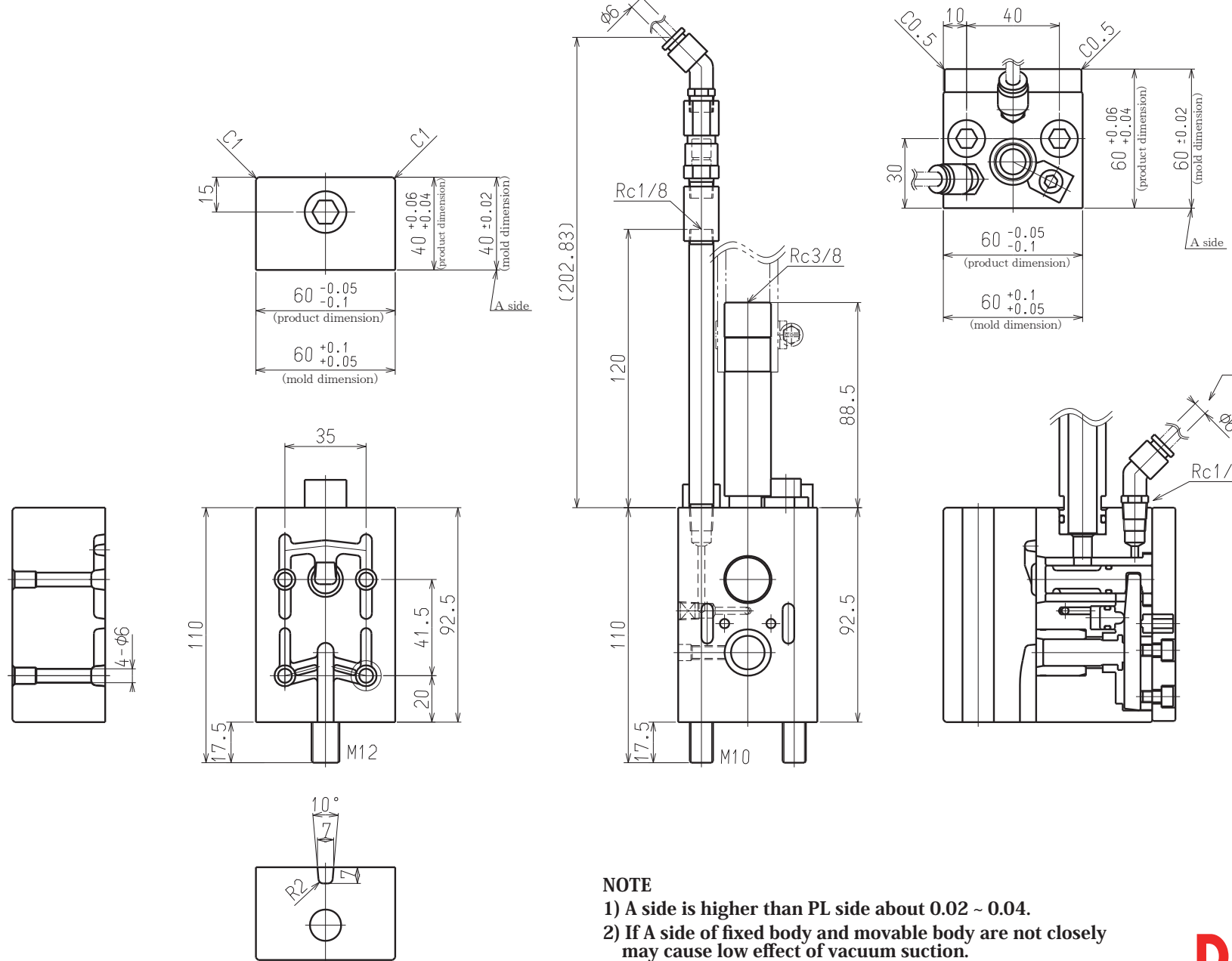

## NOTE

- 1) A side is higher than PL side about 0.02 ~ 0.04.
- 2) If A side of fixed body and movable body are not closely may cause low effect of vacuum suction.