

# ZM154 Installation drawing

During low speed or high speed no  
pressurize mode, input air here.  
( Air for valve )

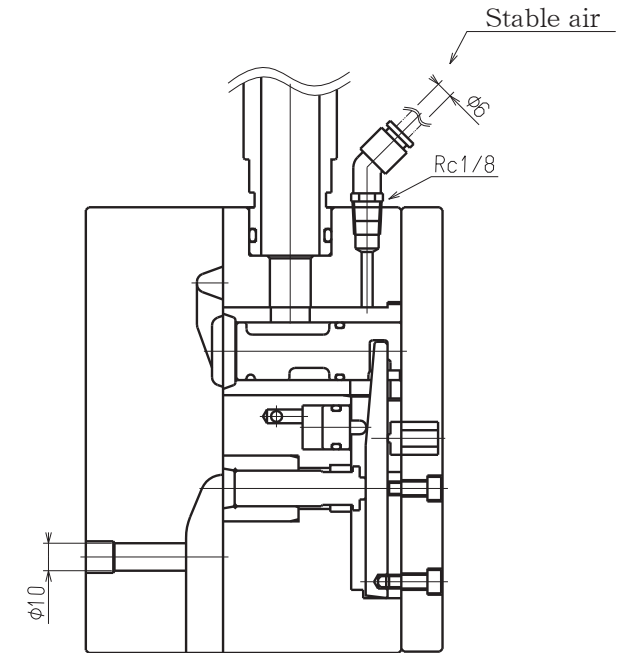
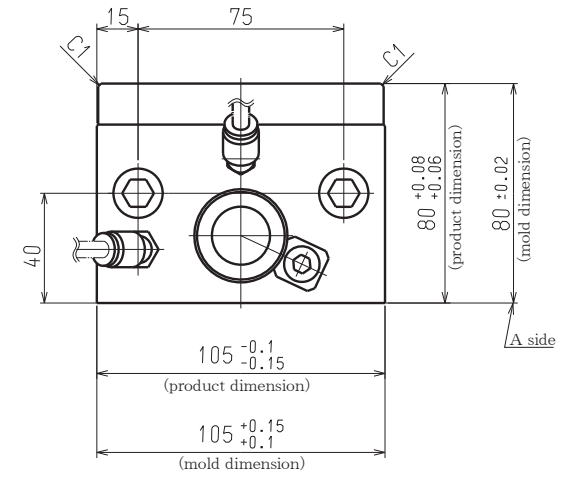
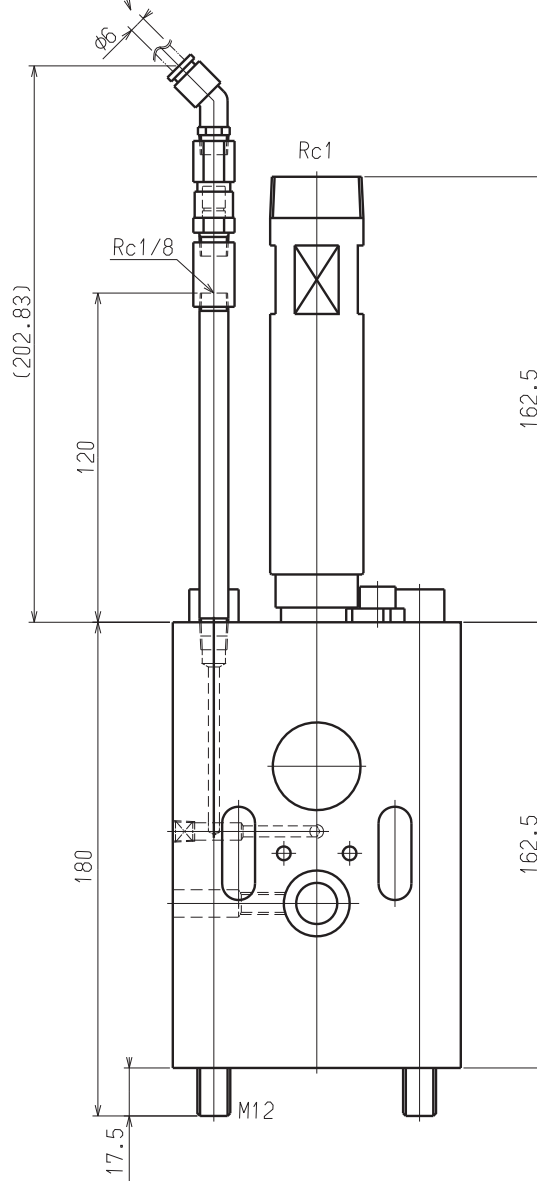
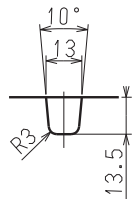
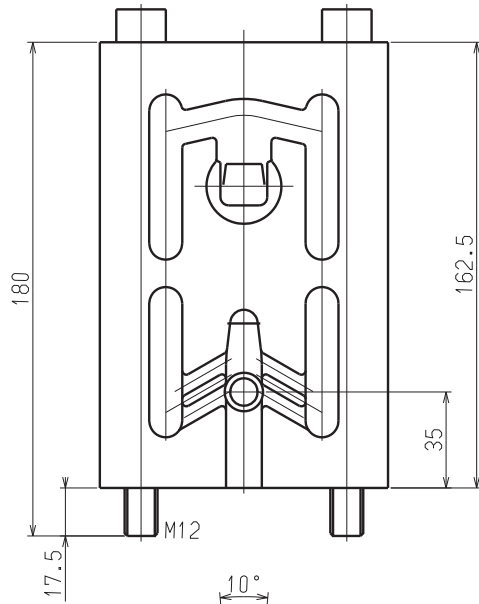
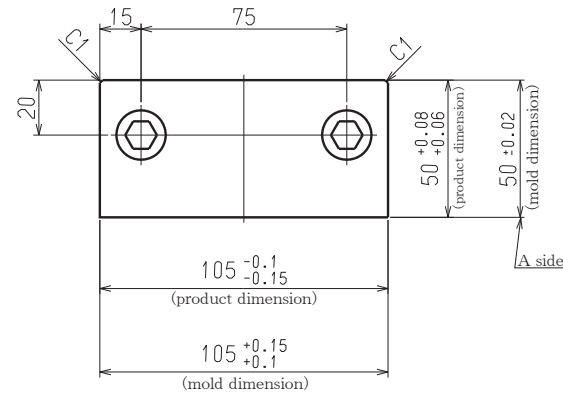

## NOTE

- 1) A side is higher than PL side about 0.04 ~ 0.06.
- 2) If A side of fixed body and movable body are not closely may cause low effect of vacuum suction.