

ZM079 Installation drawing

During low speed or high speed no
pressurize mode, input air here.

(Air for valve)

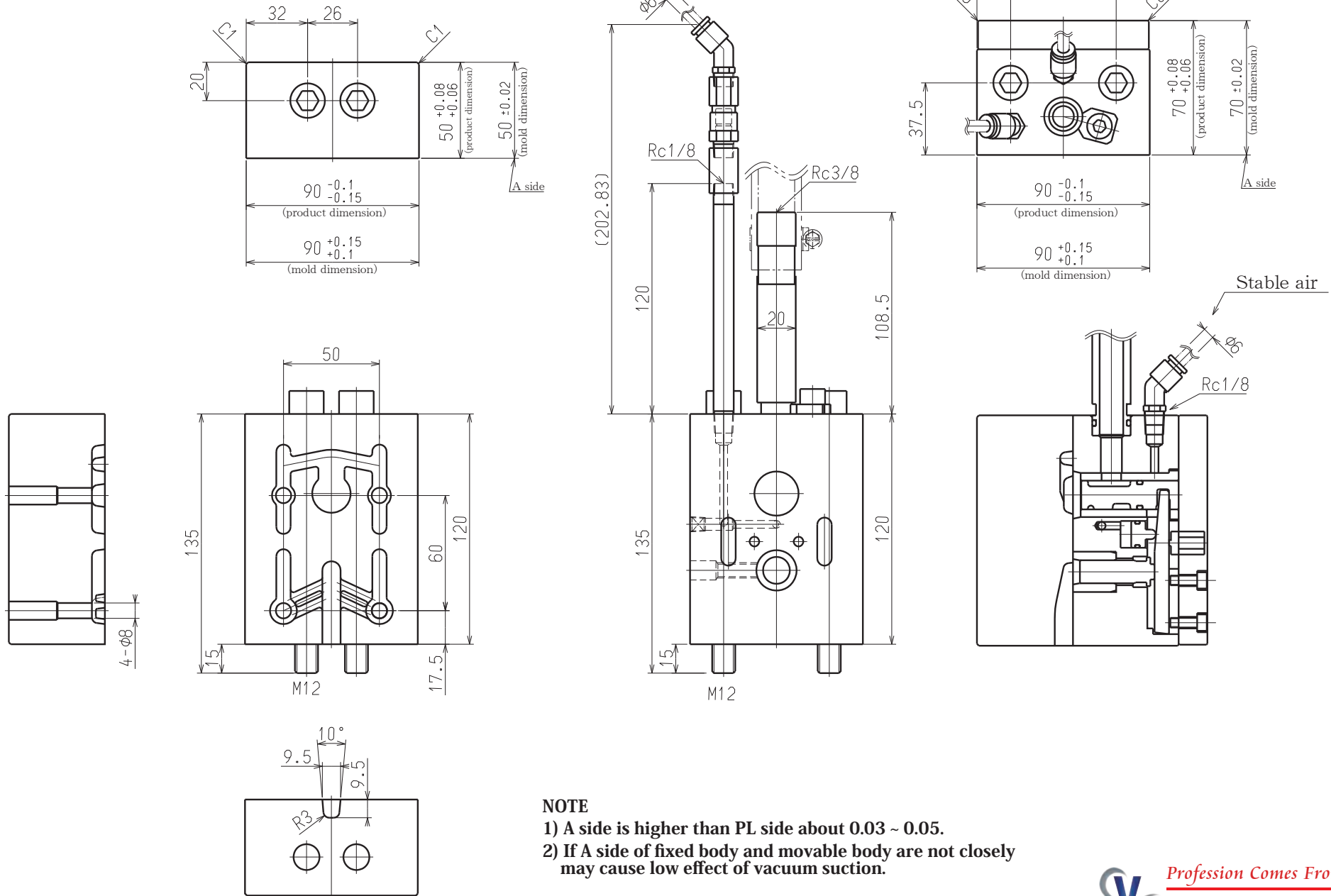

NOTE

- 1) A side is higher than PL side about 0.03 ~ 0.05.
- 2) If A side of fixed body and movable body are not closely may cause low effect of vacuum suction.